

Sash Lifts and Eyes

Traditional					
Hardware					
DIRECT					

Traditional Victorian Sash Bars

THD214B Victorian Sash Bar 600mm with Brass Ball Ends

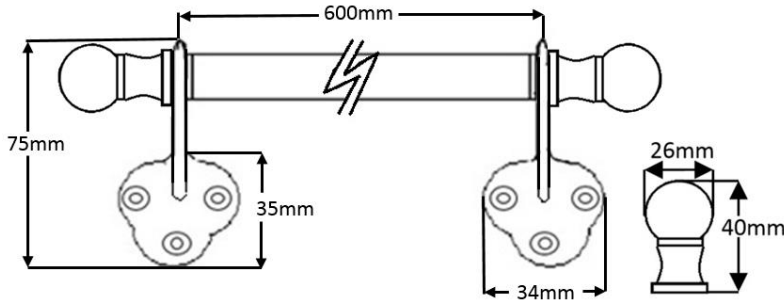

THD214B

Finishes Available

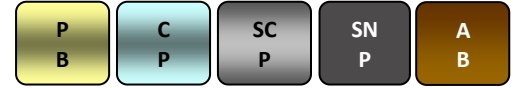

Specification

Material : Cast Brass
 Weight : 672 grams inc screws
 Size Between the Feet : 600mm
 Overall Length : 680mm
 Height of Product : 75mm
 Size of the Feet : 34mm x 35mm
 Sold as : Each
 With Screws : 6 no. 3/4" x 4 E.B.
 Steel Raised Countersunk
 Slotted W/S
 Inner Box Quantity : 2
 Outer Box Quantity : 20

Part No.	Description	Finish
THD214B/PB	Victorian Sash Bar with Brass Ball Ends – 450mm	Polished Brass
THD214B/CP	Victorian Sash Bar with Brass Ball Ends – 450mm	Chrome Plated
THD214B/SCP	Victorian Sash Bar with Brass Ball Ends – 450mm	Satin Chrome Plated
THD214B/SNP	Victorian Sash Bar with Brass Ball Ends – 450mm	Satin Nickel Plated
THD214B/AB	Victorian Sash Bar with Brass Ball Ends – 450mm	Antique Brass

NOTE : This product is made from Brass Tube and Cast Brass and manufactured using the Traditional Sand Cast method. A Threaded Steel Bar is fitted to hold the product together.
 The items requiring a Lacquer protection are protected using the Electrophoretically Lacquered process giving a very attractive long-lasting product.
 Traditional Hardware Direct will Guarantee the product against product failure due to manufacturing defects under normal usage for a period of 10 years from the date of purchase (for further information see our website).
 When cleaning the product, use a cloth soaked in warm soapy water and dry off using clean dry cloth – Do not use any chemical cleaners as this will harm the product and will break down the lacquer and tarnish the product.
 Due to the nature of the manufacturing process, a tolerance of + / - 5 % must be allowed on the weight and dimensions given on this product

**For further information Call Sales on 01254 7739465 or visit
 our website : www.traditionalhardwaredirect.com**